

# 137-3174 ALTO<sup>®</sup> 1.28

# MANSFIELD<sup>®</sup>

Elongated Front, SmartHeight<sup>™</sup> Vitreous China, Two-Piece Toilet

## FEATURES

- 3-bolt SmartFaster<sup>™</sup> tank-to-bowl connection
- 1.28 gpf / 4.8 lpf high efficiency water consumption
- Uses 20% less water than conventional toilets
- Elongated front SmartHeight<sup>™</sup> bowl
- 3-2" hybrid flapper flush valve
- Fluidmaster<sup>®</sup> anti-siphon pilot fill valve
- 12" rough-in
- Lined tank for reduced condensation
- Model 31 color-match, plastic trip lever
- 2" glazed trapway
- The Mansfield<sup>®</sup> Limited Lifetime Warranty
- Available in White



**MODEL 137-3174**

Toilet seat not included





ELONGATED



SMARTHEIGHT ADA

## COMPONENTS

MODEL #	DESCRIPTION	CODES/STANDARDS
137-3174	Elongated front, SmartHeight <sup>™</sup> two-piece toilet.	   <p>HIGH EFFICIENCY TOILET      ADA COMPLIANT</p>
137	Elongated front, SmartHeight <sup>™</sup> toilet bowl only. Less toilet seat. Specify color.	
3174	Tank and cover only with left hand, front-mount, color-match, plastic trip lever. Fluidmaster <sup>®</sup> anti-siphon pilot fill valve and tank liner. Less supply.	

## TANK TRIM & REPLACEMENT PARTS

31	Trip lever - color-match, plastic trip lever, left hand
228	3-2" Hybrid flapper flush valve
400A	Fluidmaster <sup>®</sup> anti-siphon pilot fill valve
2206	Anti-siphon pilot fill valve (compatible replacement)
630-0207	3" Replacement flapper kit
160-LID	Tank lid





# 137-3174 ALTO<sup>®</sup> 1.28



Elongated Front, SmartHeight™ Vitreous China, Two-Piece Toilet

## SPECIFICATIONS

MODEL #	DESCRIPTION	CODES/STANDARDS
137-3174	Elongated front, SmartHeight™ (1.28 gpf / 4.8 lpf) two-piece toilet	  

MATERIAL	Vitreous China
WATER PRESSURE RANGE	20 to 80 PSI
FLUSH SYSTEM	3-2" Hybrid flapper flush valve
WATER USAGE	1.28 gpf / 4.8 lpf
WATER SURFACE AREA	9' X 10'
ROUGH-IN	12"
MAP RATING	800 grams

TRAP DIAMETER	2'
TRAP SEAL	2-5/8'
SHIPPING WEIGHT	Model 137 - 56 lbs. (24 kg) Model 3174 - 34 lbs. (15 kg)
WARRANTY	Vitreous China - Limited Lifetime Tank Trim - Limited One Year

## TANK OPTIONS

3173	Standard 1.28 gpf configuration: 3-2" hybrid flapper flush valve, Fluidmaster® anti-siphon pilot fill valve, left hand, color-match trip lever.
3173RH	Variation of model 3173, with right hand, color-match trip lever.
3165	Variation of model 3173, with cover lock.
3174	Variation of model 3173, with tank liner.
3120	Variation of model 3173, with left hand, chrome trip lever.
3125	Variation of model 3173, 14" rough-in.

## TECHNICAL INFORMATION

Note: these dimensions are nominal and subject to change without notice.

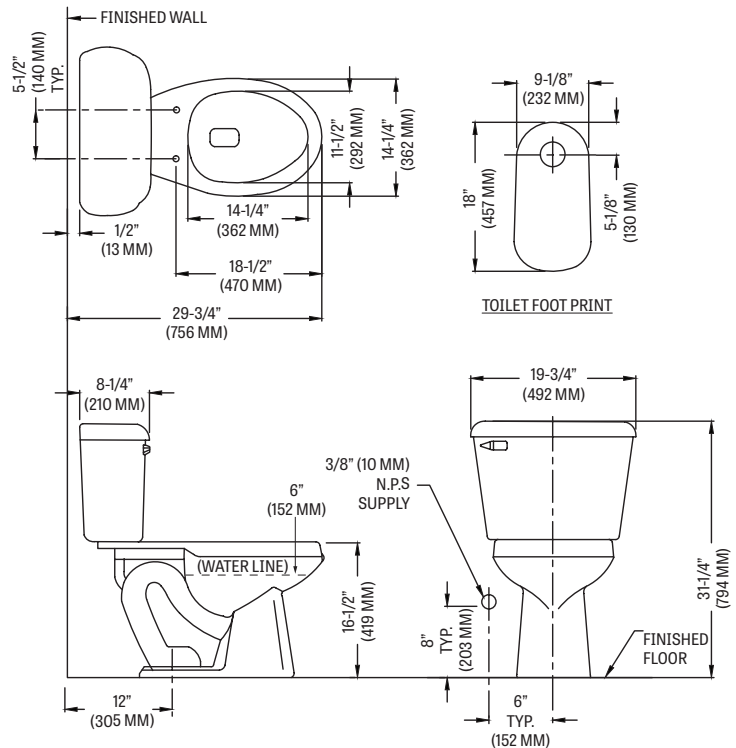

Fixture performance and specifications meet or exceed ASME A112.19.2/CSA B45.1 standards, and other state and local codes.